

THE LODGE AT WOODLOCH

ROOM	SQFT	CLASSROOM	THEATER	U-SHAPED	BANQUET	RECEPTION	BOARD ROOM
THE FIRESIDE ROOM	1350'	56	88	30	56	70	-
FIRESIDE EAST	590'	24	40	-	-	30	-
FIRESIDE WEST	760'	32	48	-	-	30	-
THE RIVER BIRCH	230'	-	-	-	-	-	12

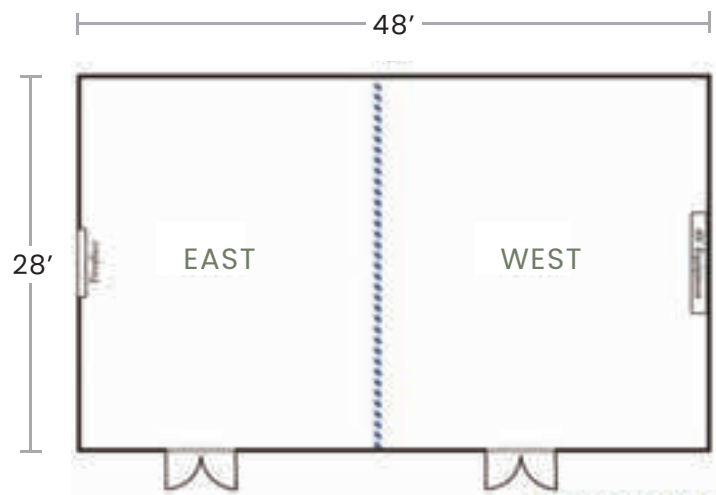

THE FIRESIDE ROOM

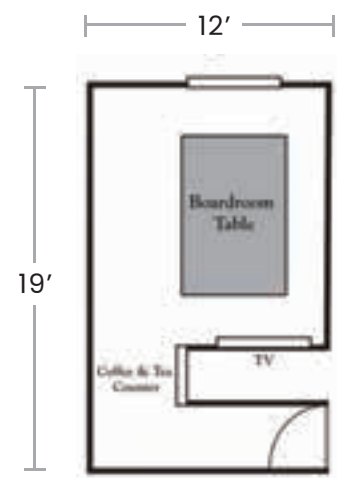

THE RIVER BIRCH



Meeting Rooms

WOODLOCH SPRINGS

WOODLOCH PINES

ROOM	DIMENSIONS	SQFT	CLASSROOM	THEATER	U-SHAPED	BANQUET	RECEPTION	ROOM	DIMENSIONS	SQFT	CLASSROOM	THEATER	U-SHAPED	BANQUET	RECEPTION
VISTA & TERRACE	70' x 34'	2500'	130	200	NA	190	225	MT. LAUREL	100' x 40'	4000'	180	300	NA	220	300
VISTA	40' x 37'	1480'	60	166	32	100	120	MT. LAUREL DIV 1	70' x 40'	2800'	120	200	40	150	170
TERRACE	30' x 34'	1020'	40	80	24	75	80	MT. LAUREL DIV 2	30' x 40'	1200'	50	100	24	60	100
GRILLE	40' x 40'	1600'	60	80	30	60	100	LAKEVIEW	78' x 40'	3120'	100	180	30	150	230
CLUB CONFERENCE	29' x 38'	1100'	50	78	30	60	80	KEYSTONE	46' x 45'	2100'	100	150	36	120	150
LIBRARY	28' x 20'	560'	29	45	20	36	50	YORK ROOM	36' x 31'	1116'	50	75	30	NA	NA
FAIRWAY	24' x 19'	456'	24	45	16	36	50	NIGHTCLUB	-	8000'	600	NA	NA	NA	600

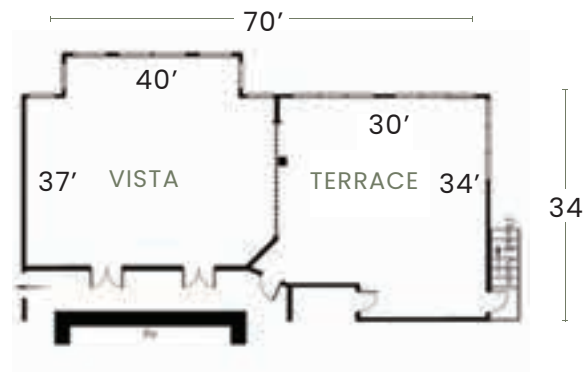

VISTA & TERRACE

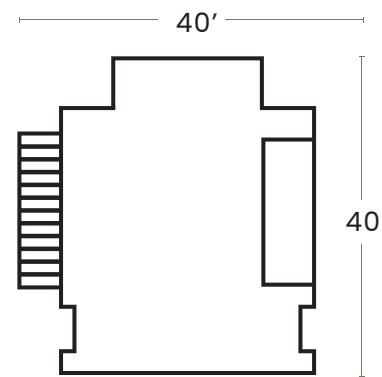

GRILLE

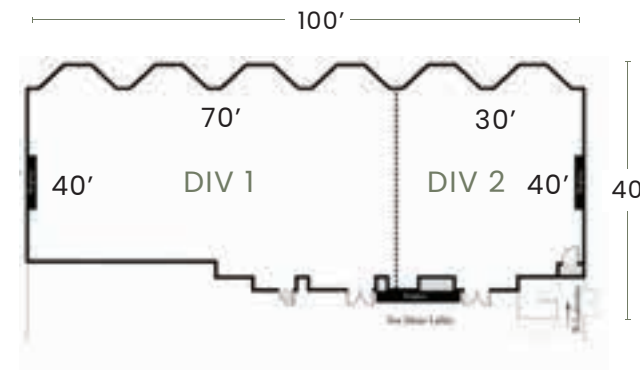

MOUNTAIN LAUREL

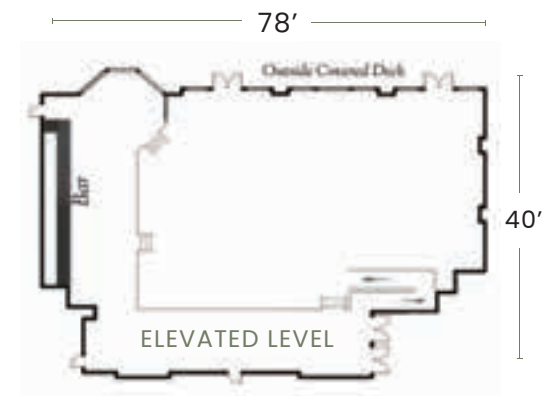

LAKEVIEW

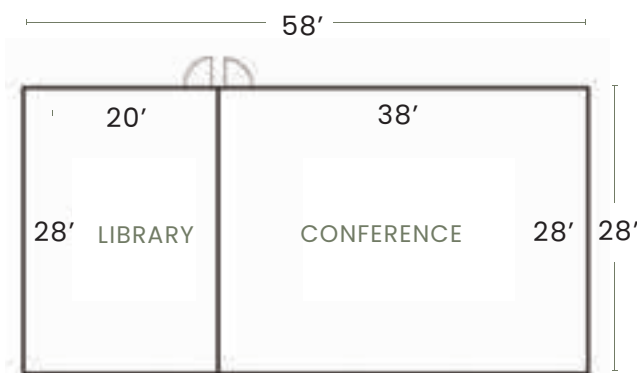

LIBRARY & CLUB CONFERENCE

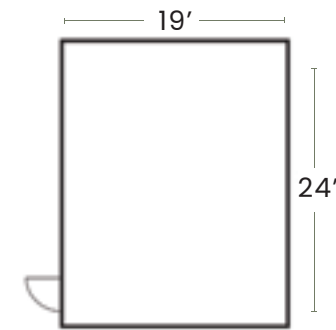

FAIRWAY

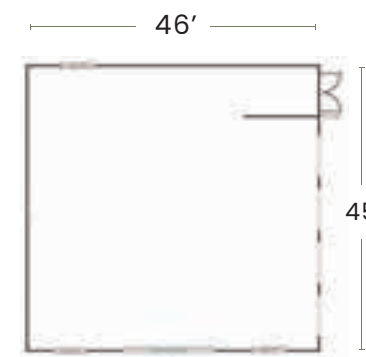

KEYSTONE

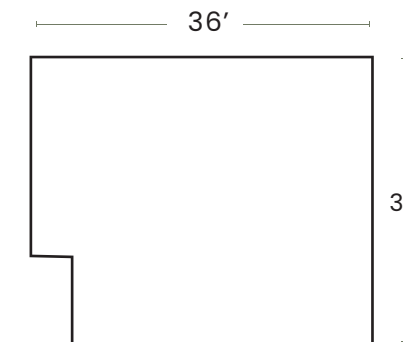

YORK ROOM

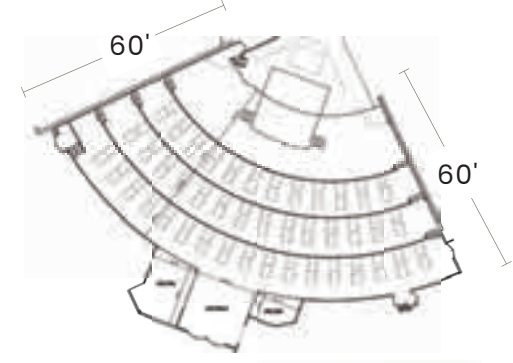

NIGHTCLUB